

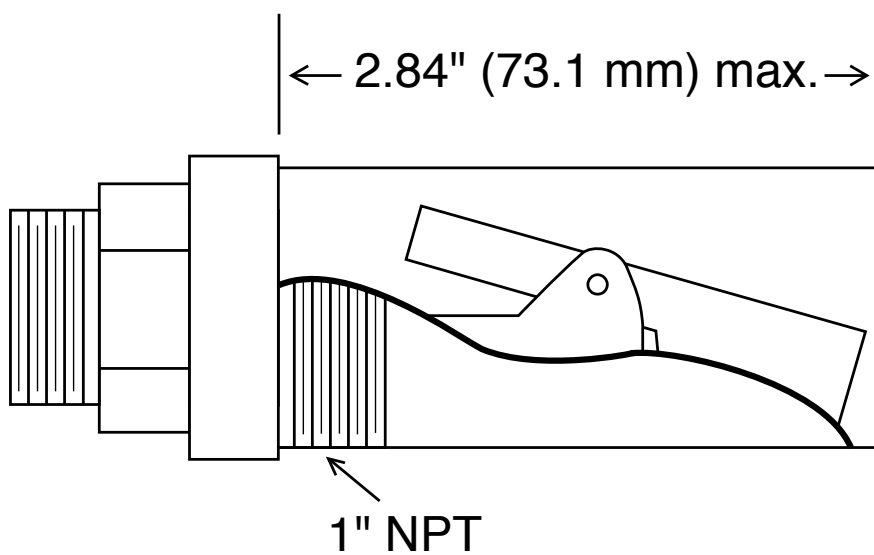

Niveauschalter

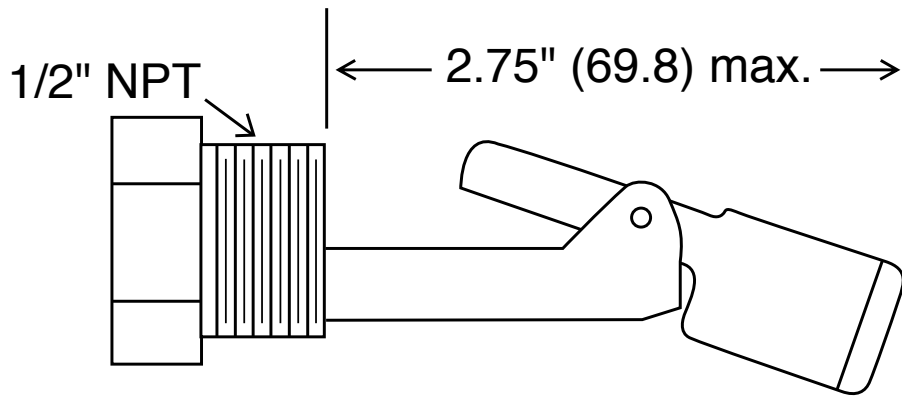

Ausschnitt zeigt
Schwappschutzbetrieb

Zeich. Nr. 35