

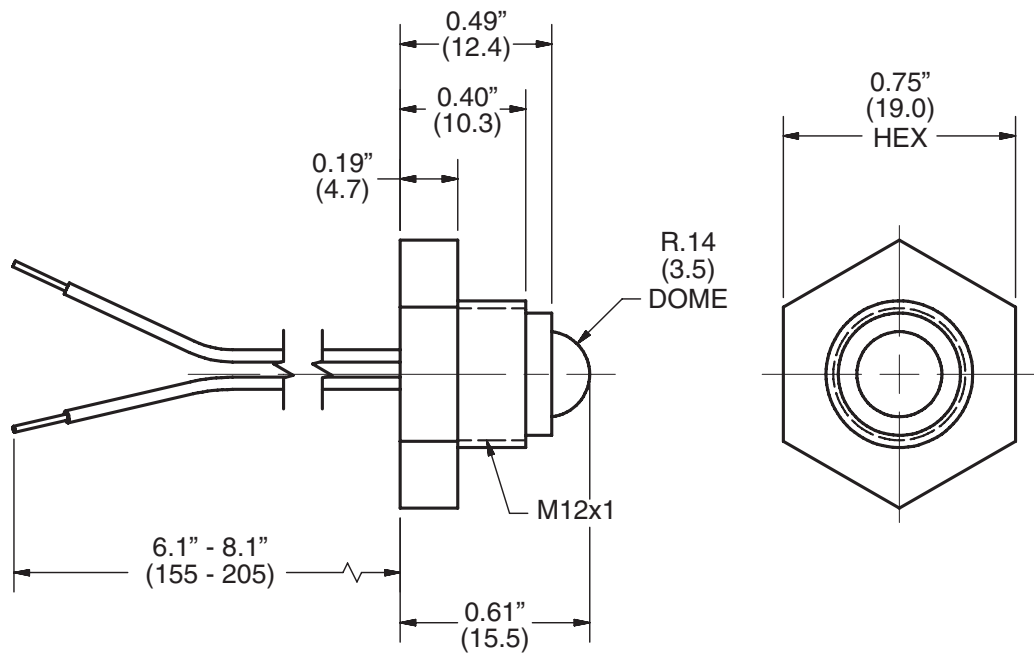

Optical Level Switches



DWG No. O-1